

3DoF Model Helicopter with Hybrid Control

Arbab Nighat Khizer^{1*}, Dai Yaping², Syed Amjad Ali³, Xu Xiang Yang⁴

^{1,2,4}School of Automation, Beijing Institute of Technology, Beijing 100081, P. R. China

³School of Mechatronics, Beijing Institute of Technology, Beijing 100081, P. R. China

^{1,3}Mehran University of Engineering and Technology, Jamshoro, Sindh, Pakistan

*Corresponding author, e-mail: arbabnighat@gmail.com

Abstract

Dynamics of miniature unmanned helicopter are considered nonlinear and mutually coupled; therefore designing of a stable control becomes a big challenge for researchers. This paper addresses this issue by proposing a hybrid control methodology using both traditional and intelligent control. A 3DoF model helicopter system is used as a controlled platform. This hybrid control used PID as a traditional and fuzzy as an intelligent control so as to take the full advantage of advanced control theory. Proposed hybrid control is evaluated against the fuzzy and PID control through intensive simulation. Results verified that the proposed control has an excellent performance in static as well as dynamic environment as compared to individual PID and fuzzy control.

Keywords: 3DoF model helicopter dynamics, PID control, fuzzy control, hybrid control.

Copyright © 2014 Institute of Advanced Engineering and Science. All rights reserved.

1. Introduction

Unmanned Ariel vehicles (UAV) are observed as a main research application in the military, civil and academic fields because of its flying capabilities such as taking off, hover and landing. Unique characteristics and maneuverability makes the helicopter more suitable for channeling environment [1-2]. 3DoF model helicopter is a good choice for implementing and checking the different control strategies [3-6]. Conventional controllers seem inadequate for achieving the stable control because of imprecise mathematical modeling and bad tuning of parameters therefore this situation gives strong motivation to intelligent control. Based on excellent performance of intelligent control, it can be successfully applied in aerospace control field. Fuzzy control is closer to human thinking than conventional control system and generally belongs to intelligent control [7-10]. It provides a way through which linguistic control strategy based on expert human knowledge is converted into an automatic control strategy. It can be able to handle inconsistent real data in to a suitable way for variety of control applications. A work on fuzzy control for 3DOF laboratory helicopter's elevation and travel control was discussed in [11]. Excessive rules were applied, ultimately takes excessive simulation time and therefore implementation in real-time becomes not viable. Fuzzy control was also applied to address only elevation attitude in [12]. In another approach optimal tracking strategy using both control i-e fuzzy and LQR for model helicopter was proposed in [13]. Fuzzy and PID combined control used for an unmanned helicopter was discussed in [14]. A Mamdani controller was designed for an altitude and attitude control.

In this paper, a hybrid control is proposed which combines the convenient control of PID together with flexible control of fuzzy for 3DoF model helicopter. Firstly, model helicopter structure and dynamics are analyzed. A mathematical model based on dynamical results is then developed. Initially traditional control is offered to 3DoF model as a basis for controller improved results. Then, the intelligent control is applied to get the dynamical stability. Both PID and fuzzy control has their own advantages. Based upon their respective performance, PID and fuzzy control are combined together as a hybrid control to investigate the flying motion of model helicopter.

The paper is organized as follows. Section-2 presented structural dynamics and mathematical equations for model helicopter. Section-3 discussed PID, fuzzy and hybrid control design. Simulation results are presented to illustrate the efficiency of proposed control in section-4. Finally, section-5 presented conclusion remarks.

2. 3DoF Model Helicopter

2.1. Nomenclature

Notations are related to Figure 2-4.

J_e	inertia moment of system about the elevation axis
m_b	mass of balance block
m_h	total mass of two propeller motor
V_1 and V_2	front and back motor voltages
K_c	force constant of the motor/propeller combination
l_1 and l_2	distance from the pivot point to propeller motor and to balance blocks
T_g	effective gravitational torque
$\ddot{\epsilon}$	angular acceleration of elevation axis
J_p	inertia moment of system about the pitch axis
l_p	distance from the pitch axis to either motor
\ddot{P}	angular acceleration of pitch axis
J_r	inertia moment of system about the travel axis
\dot{r}	travel rate in radian/sec
$\epsilon(s)$ and $P(s)$	Elevation angle and Pitch angle (in degrees)
$r(s)$	Travel angle (in degrees)

2.2. Helicopter Structure

3DoF helicopter is considered as an experimental system for automatic control and aerospace field. The whole system consists of main body of model helicopter with electrical control box and control platform. The helicopter main body system is composed of base, balancing block and propellers as shown in Figure 1. Two Propellers and balance block are installed at either ends of balance bar. Pitching motion is due to propellers rotational lift which turns balance bar around the fulcrum. Encoders are installed to measure the rotation axis along with pitch angle. Balance block is used to reduce the rise of helicopter. Installation of encoder over the rod connects the two propellers for measuring the overturned angle. Propellers with brushless DC motors are responsible for momentum. Propeller motor output can be adjusted through the balance rod installed on side of balance block. All signals are transmitted via slip ring to and from the body thus to reduce the friction amount and loading around the moving axes [15].

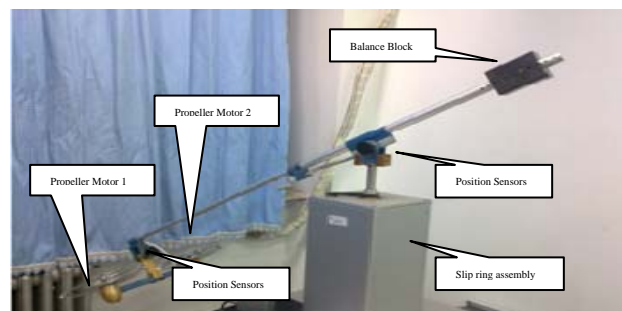

Figure 1. 3DoF Model Helicopter System

2.3 Mathematical Model

The mathematical model for 3DoF model helicopter is described by three differential equations.

2.3.1. Elevation Dynamics

Movement differential equations for Figure-2 are as follows:

$$J_e \ddot{\epsilon} = l_1 F_h - l_1 G = l_1 (F_1 + F_2) - l_1 G \tag{1}$$

$$J_e \ddot{\epsilon} = K_c l_1 (V_1 + V_2) - T_g = K_c l_1 (V_s) - T_g \tag{2}$$

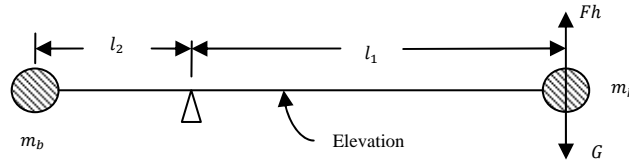

Figure 2. Elevation Axis Dynamics

2.3.2. Pitch Dynamics

Figure 3 shows the simple pitch axis and its control is done by the difference of forces, produced by two propellers. The differential equation becomes:

$$J_p \ddot{p} = F_1 l_p - F_2 l_p \tag{3}$$

$$J_p \ddot{p} = K_c l_p (V_1 - V_2) = K_c l_p V_d \tag{4}$$

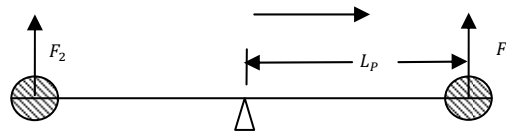

Figure 3. Pitch Axis Dynamics

2.3.3. Travel Dynamics

A horizontal component of G is responsible for a torque about the travel axis, which further results in acceleration. This becomes done when tilting and overturning of pitch axis occurs. Suppose the model has pitching up by an angle (p) as depicted in Figure 4:

$$J_r \dot{r} = -G \sin(p) l_1 \tag{5}$$

$$J_r \dot{r} = -K_p \sin(p) l_1 \tag{6}$$

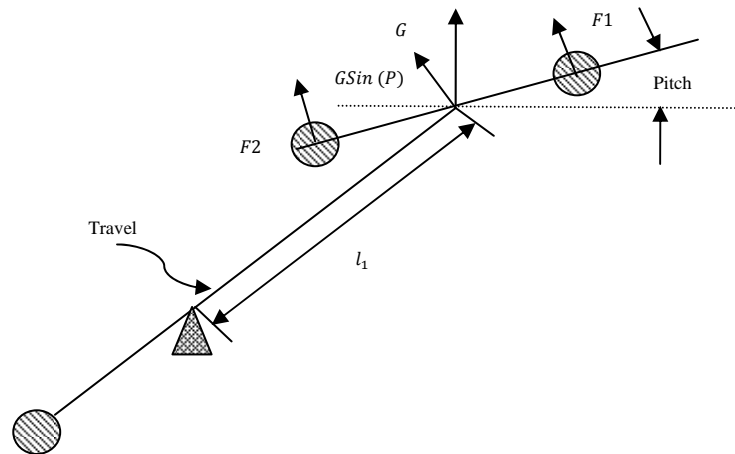

Figure 4. Travel Axis Dynamics

3. Control Design

3.1. PID control

Initially, PID control is used for 3Dof model helicopter to control its three axes i.e elevation, pitch and travel. It is cleared from dynamics that two axes (travel and pitch axes) are coupled, therefore only two signals are required. PID controllers are implemented separately for three axes in this setup with the help of transfer functions. Equation (7)-(9) is the transfer functions which are derived from each axis dynamics. Ignore the gravity torque disturbance " T_g ". Simulink diagram of PID control along with three transfer functions are shown by Figure-5.

$$\frac{\varepsilon(s)}{\varepsilon_c(s)} = \frac{\frac{K_c K_{ep} l_1}{J_e}}{s^2 \frac{K_c K_{ed} l_1}{J_e} s - \frac{K_c K_{ep} l_1}{J_e}} \equiv \frac{8.761}{s^2 + 4.185s + 8.761} \tag{7}$$

$$\frac{P(s)}{P_c(s)} = \frac{\frac{K_c K_{pp} l_p}{J_p}}{s^2 \frac{K_c K_{pd} l_p}{J_p} s - \frac{K_c K_{pp} l_p}{J_p}} \equiv \frac{19.71}{s^2 + 6.278s + 19.71} \tag{8}$$

$$\frac{r(s)}{r_c(s)} = \frac{\frac{K_{rp} G_{l_1} s + K_{ri} G_{l_1}}{J_r}}{s^2 \frac{K_{rp} G_{l_1}}{J_r} s - \frac{K_{ri} G_{l_1}}{J_r}} \equiv \frac{0.6278s + 0.1971}{s^2 + 0.6278s + 0.1971} \tag{9}$$

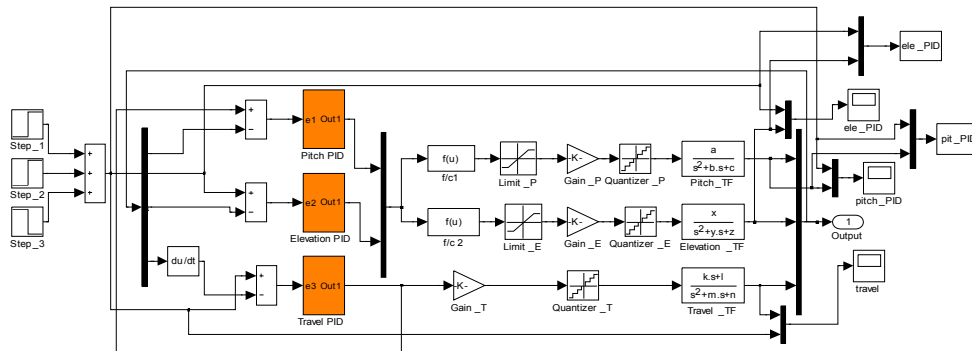

Figure 5. Simulink Model using PID Control

3.2. Fuzzy control

Simple fuzzy if-then rules for stable and effective control are primary requirement for designing the fuzzy control [16]. For 3Dof helicopter's elevation and pitch control, two inputs i.e error (e) and error rate (\dot{e}) and single output (u) are selected. Universe domain for both input and output is normalized between the range [-1 1]. Triangular membership functions are used for elevation and pitch control. Linguistic variables covered seven values as shown in Table 1.

Table 1. Meaning of Linguistic Variables in Fuzzy Inference System (FIS)

Negative big	NB
Negative middle	NM
Negative small	NS
zero	ZR
positive small	PS
positive middle	PM
positive big	PB

Figure 6-7 showing the input and output membership function for elevation and pitch axis. The triangular output membership functions for both controllers keep narrower near the zero in order to decrease the gain of controller around the set point for better steady-state control. This is also useful for avoiding the excessive overshooting [17].

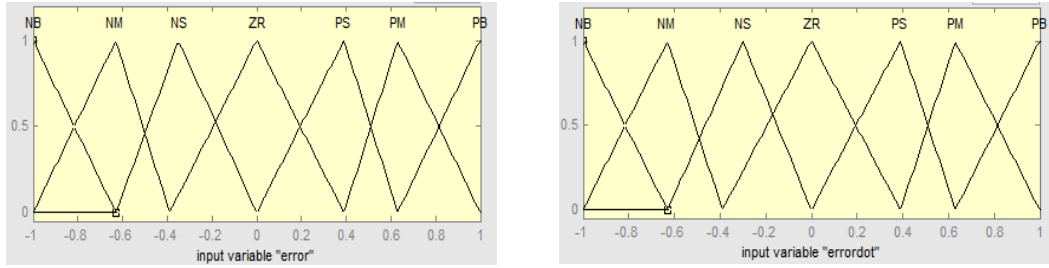

Figure 6. Input Membership Functions for Elevation and Pitch Control

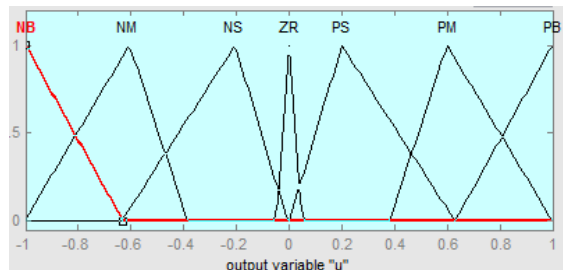

Figure 7. Output Membership Function for Elevation and Pitch Control

System behavior is defined by simple fuzzy rules using input error signals e and \dot{e} and control output signal (u). The same rules are designed for both elevation and pitch fuzzy control, since seven fuzzy sets are used for input and output universes discourse, therefore each rule base consist of 7 by 7 arrays. Table 2 shows the rule base for Pitch/ elevation control.

Table-2 Fuzzy Rule Base for Pitch and Elevation Axis

\dot{e}/e	NB	NM	NS	ZR	PS	PM	PB
NB	NB	NB	NB	NB	NM	NS	ZR
NM	NB	NB	NB	NM	NS	ZR	PS
NS	NB	NB	NM	NS	ZR	PS	PM
ZR	NB	NM	NS	ZR	PS	PM	PB
PS	NM	NS	ZR	PS	PM	PB	PB
PM	NS	ZR	PS	PM	PB	PB	PB
PB	ZR	PS	PM	PB	PB	PB	PB

3.2 Hybrid Control

Classical PID control is known as for excellent static performance, while intelligent fuzzy control has better performance in dynamic environment. This hybrid control combines the merits of both so as to give the stable and effective quick control simultaneously. Working principle of hybrid control is based on system deviation; therefore threshold deviation is set prior. This control strategy is illustrated by Figure 8.

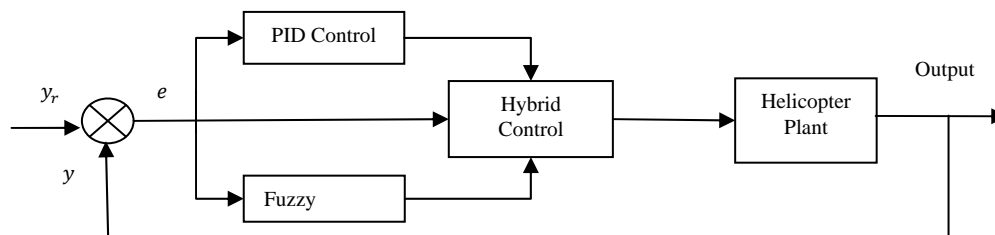

Figure 8. Block Diagram of Hybrid Control

3.3.1. Structure of PID Control

For this hybrid control, PID structure is given as:

$$e(k) = y_{ref} - y \tag{10}$$

$$u_{PID}(k) = K_P e(k) + K_I \sum_{i=1}^k e(k) + K_D \dot{e}(k) \tag{11}$$

Where e is error between reference signal (y_{ref}) and output (y). K_P , K_I and K_D are gains of PID control.

3.3.2. Structure of Fuzzy control

Fuzzy control has two inputs (error(e) and change rate of the error (de)) and one output (u_{fuzzy}). All variables are used as linguistic values and defined by seven linguistic values such as NB, NM, NS, Z, PS, PM, and PB. Scaling factors are introduced in the hybrid fuzzy control to obtain real interval of variables as shown in the Figure 9. Triangular membership functions for input and output are used to represent the linguistic values.

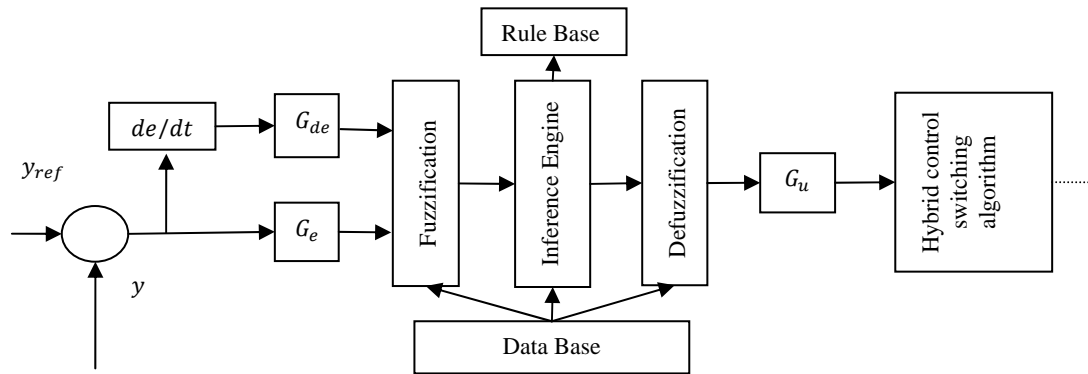

Figure 9. Fuzzy Structure for Hybrid Control

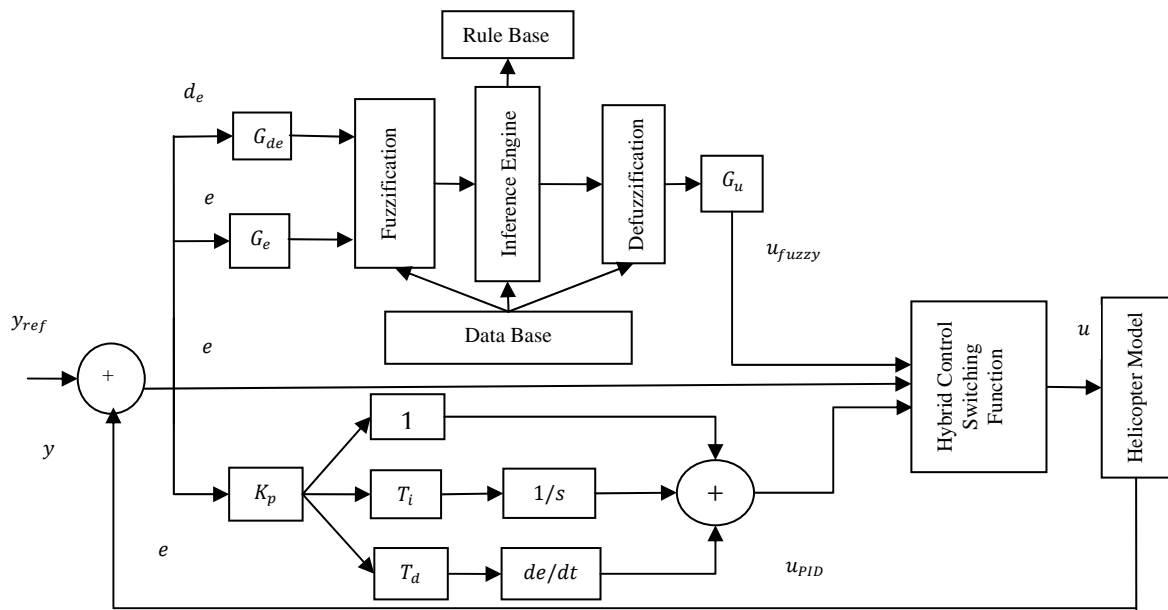

Figure 10. Hybrid Control Structure

The fuzzy rule for hybrid control is:

$$R^i: \text{If } x_1 \text{ is } A_1^i \text{ and } \dots \text{ and } x_n \text{ is } A_n^i \text{ then } y^i = B^i \quad (12)$$

Where x_i is input variable for i^{th} rules, y^i is the output variable for the i^{th} rule. A_i is a fuzzy set, and b^i is a crisp value. For a given input (x_1, x_2, \dots, x_n) at time (t) , the degree of matching in the premise for i^{th} rule and output of fuzzy is inferred by considering the weighted average of Y^i are calculated as follows:

$$w^i = A_1^i(x_1) \times A_2^i(x_2) \times \dots \times A_n^i(x_n) \quad (13)$$

$$u_{fuzzy}(k) = \frac{\sum_{i=1}^n (w^i \cdot b^i)}{\sum_{i=1}^n w^i} \quad (14)$$

The overall hybrid control structure is shown by Figure 10.

3.3.3. Design of Hybrid Switching Function

During the control process when error reaches higher values than threshold deviation, fuzzy control is selected because it has a fast rise time and ability to depress the overshoot. In other situation, when error is below the threshold deviation or close to required reference point, PID control is used due to its excellent accuracy and stabilization near the set point. To utilize this situation, a hybrid switching function is introduced here as:

$$u = e(k)u_{fuzzy} + [1 - e(k)]u_{PID} \quad (15)$$

When the absolute value of error is greater than $e_{thr(b)}$, the fuzzy control is selected and try to accelerate the error convergence; when error is less than the absolute value of $e_{thr(b)}$ and greater than $e_{thr(a)}$ ($0 < e_{thr(a)} < e_{thr(b)}$), the both (PID control and fuzzy control) used to work in different proportions; when absolute error is less than $e_{thr(a)}$, the PID control selected and operates alone. In this way, the hybrid switching function $e(k)$ can be described as below:

$$e(k) = \begin{cases} 0 & |e| < e_{thr(a)} \\ e^{[\alpha(|e| - e_{thr(a)})] \frac{|e| - e_{thr(a)}}{e_{thr(b)} - e_{thr(a)}}} & e_{thr(a)} \leq |e| \leq e_{thr(b)} \\ 1 & |e| > e_{thr(b)} \end{cases} \quad (16)$$

Where α is coefficient having great influence on changing of $e(k)$, and ultimately this change will tend for tuning the impact of fuzzy and PID control. Smaller the value of α , bigger the role of fuzzy control in transitional region, similarly, the larger the value of α , smaller the role of fuzzy control in transitional region. Hybrid switching function $e(k)$ with $\alpha = 0$ is shown in the Figure 11.

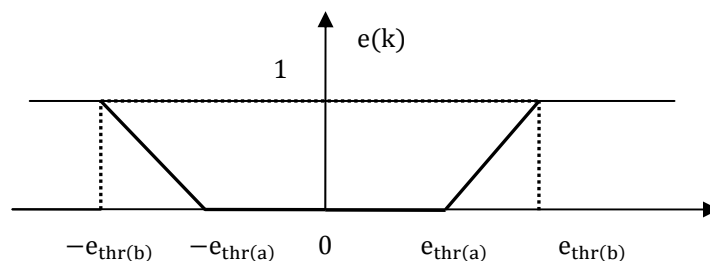

Figure 11. Curve of Hybrid Switching Function when $\alpha = 0$

4. Simulation Results

3DoF helicopter's performance is investigated through number of simulation with PID and fuzzy control. The gains of PID controller are adjusted manually in such a way that first increasing K_p to achieve a desired response then K_i and K_d are adjusted to obtain the optimal response of controlled object. After using trail-error techniques, three appropriate PID gains are selected, and showing by Table 3.

Table 3. PID Gain Values

Parameter	K_{ep}	K_{ed}	K_{ei}	$\square\square$	$\square\square$	$\square\square$	$\square\square$	$\square\square$	$\square\square$
value	5.0	3.8	0.9	0.08	0.0005	0.002	0.5	0.2	0.08

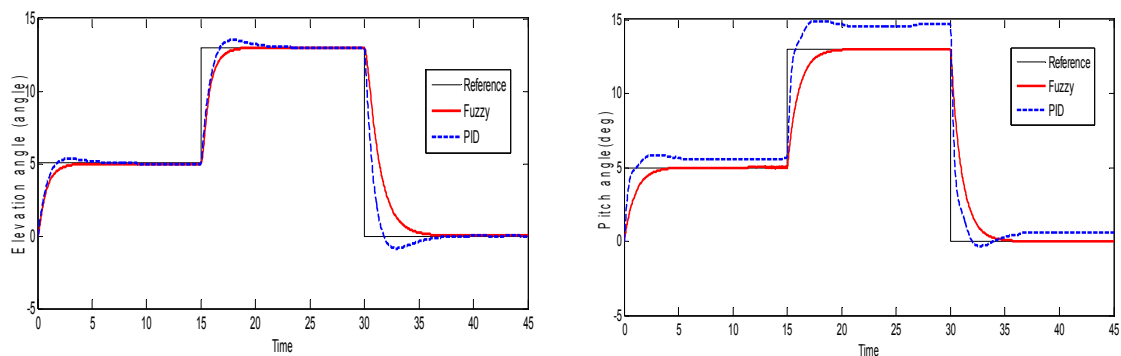

Figure 12. Elevation (left) and Pitch (right) Angle using PID and Fuzzy Control

The Figure 12 illustrated control curves using PID and fuzzy control. It is cleared from simulation results that attitude adjustments are required for model helicopter. For PID control, different magnitude of gains is applied to get better response. Figure show that PID control for pitch axis has large overshoot and could not be able to track the desired response. Even in elevation axis control some overshoot is observed and required long rising time. When After introducing the fuzzy control to model helicopter for elevation and pitch axis and compared with the steady results of PID control, fuzzy curves clearly trying to overcome the overshooting and output tracking can be done in well manner. The rising time still appeared as main issue with these two controls. In this situation, a hybrid control is introduced and applied to system as shown in Figure 13.

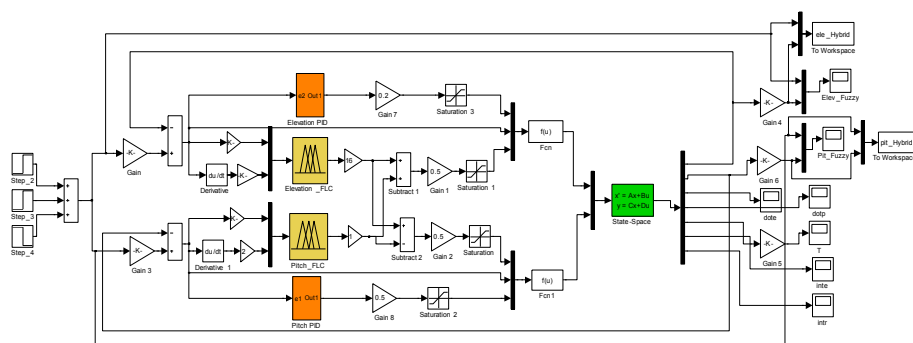

Figure 13. Simulink 3Dof Model using Hybrid Control

The elevation and pitch output response of hybrid control are showing by Figure 14. Compared to conventional PID and fuzzy control, better responses of two axes (elevation and

pitch) are observed. Proposed hybrid control shows the excellent result for rising time, settling time, overshoot and steady state error and is more acceptable than other two controls. The simulated response characteristics of 3DoF Hybrid control are satisfactory in terms of parameter metrics. Figures 15 showing the performance metrics for both elevation and pitch axis using three controls.

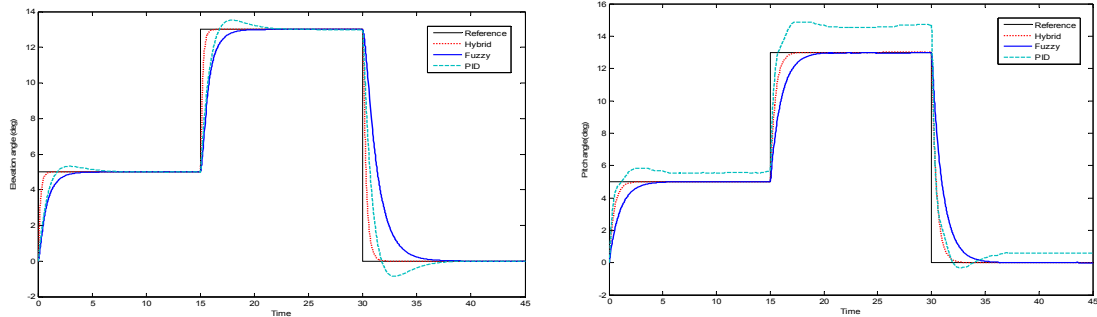

Figure 14. Elevation Response (left) and Pitch Response (right) using Hybrid Control

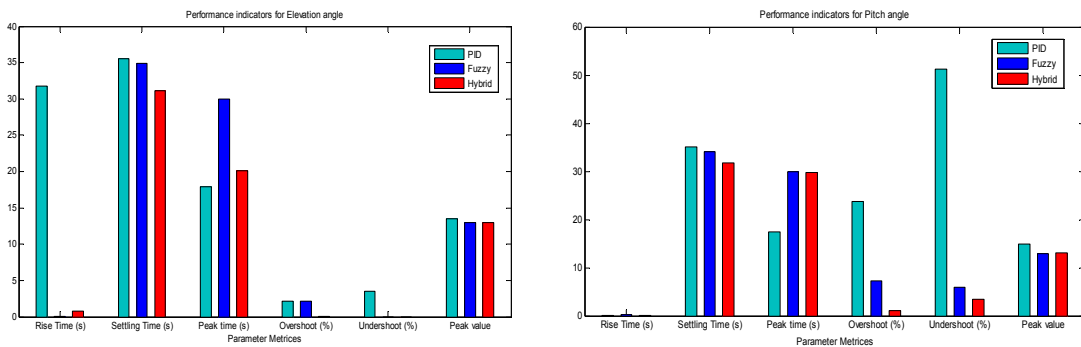

Figure 15. Performance Indicators for Elevation Angle (left) and Pitch Angle (right)

5. Conclusion

The 3DoF model helicopter dynamical equations along with simulation results are presented in the paper. Based on the system dynamical equations PID, fuzzy and hybrid control are designed and successfully applied in the simulation process. From the simulated results, performance of hybrid control is found to be excellent as compared with PID and fuzzy control. This paper presents the simple approach for designing the hybrid control based on switching logic with satisfactory performances. It has both static and dynamic performance, therefore the stability and the quick control effect can be obtained simultaneously. The robustness of designed hybrid control is superior in terms of zero overshoot, short settling time and stable tracking of reference inputs.

References

- [1] J Shan, H T Liu, S Nowotny. Synchronized Trajectory-tracking Control of Multiple 3DOF Experimental Helicopters, *IEEE Proceedings of Control theory Appl.* (S1350-2379). 2005; 152(6): 683-692.
- [2] M Lopez-Martinez, M G Ortega, C Vivas, F R Rubio. Nonlinear L2 control of a laboratory helicopter with variable speed rotors, *Automatica*. 2007; 43(4): 655-661.
- [3] Yu Yao, Zhong YiSheng. Robust Attitude Control of a 3DOF Helicopter with Multi-operation Points, *Journal of system Science & Complexity*. 2009; 207-219.
- [4] Mariya A. Ishutkina. Design and Implementation of a Supervisory Safety Control for 3DOF Helicopter, Master Thesis, *Department of Aeronautics and Astronautics, MIT*. 2004.

-
- [5] Yue Xincheng, Yang Ying, Geng Zhi-qiang. No Steady-State Error Tracking Control of 3Dof Experimental Helicopter System, *Journal of System Simulation*. 2007; 19(18):4279-4283.
- [6] Zhao Xiaoxiao, Dong Xiucheng. 3Dof helicopter control system based on LQR optimal controller, *Journal of Kunming University of science and technology*. 2005; 30(5):125-127.
- [7] Yu Yongquan, Huang Ying, Zeng Bi. *A PID neural network controller*. Proceedings of IJCNN, Portland, U.S.A. 2003; 1-4: 1933-1938.
- [8] KS Tang, KF Man, G Chen, S Kwong. An optimal funy PID controller. *IEEE Trans. Indust, Elecrmn*, 2001; 48(4).
- [9] GK MaM, BG Hu, RG Gosine. Analysis of direct action fuzzy PID Controller Structures. *IEEE Tram, on Spt., Mon. Cybem*. 1999; 29(3): 371-388.
- [10] VA Oliveira, LV Cossi, MCM Teixeira, AMF Silva. Synthesis of PID controllers for a class of time delay systems. *Automatica*. 2009; 45(7): 1778-1782.
- [11] Malgorzata S Zywno. *Innovative Initiatives in Control Education at Ryerson Polytechnic University Fuzzy Logic Control of the 3D-Helicopter Simulator*. Proceedings of the American Control Conference Chicago. 2000.
- [12] Feng Zhou, Denghua Li, Peirong Xia. *Research of Fuzzy Control for Elevation Attitude of 3DOF Helicopter*. International Conference on Intelligent Human-Machine Systems and Cybernetics. 2009; 367-370.
- [13] Zhichao Liu, Zouhair Choukri el haj, Hongbo Shi. *Control Strategy Design Based on Fuzzy Logic and LQR for 3-DOF Helicopter Model*. International Conference on Intelligent Control and Information Processing. *China*. 2010.
- [14] EN Sanchez, HM Becerra, CM Velez. *Combining Fuzzy and PID Control for an Unmanned Helicopter*. Annual Meeting of the North American Fuzzy Information Processing Society. 2005; 235-240.
- [15] Googol Technology, *3DOF Helicopter Experimental manual*, product information, Hong Kong. 2007.
- [16] K Tanaka, M Sugeno. Stability analysis and design of fuzzy control systems. *Fuzzy Sets Syst.*, 1992: 45: 135–156.
- [17] KM Passino, S Yurkovich. Fuzzy Control, First edition. *Addition Wesley Longman Inc, USA*. 1998.